

PILETTA 2" RIFERIMENTO TOP
 SCHEDA TECNICA CODICE MC00

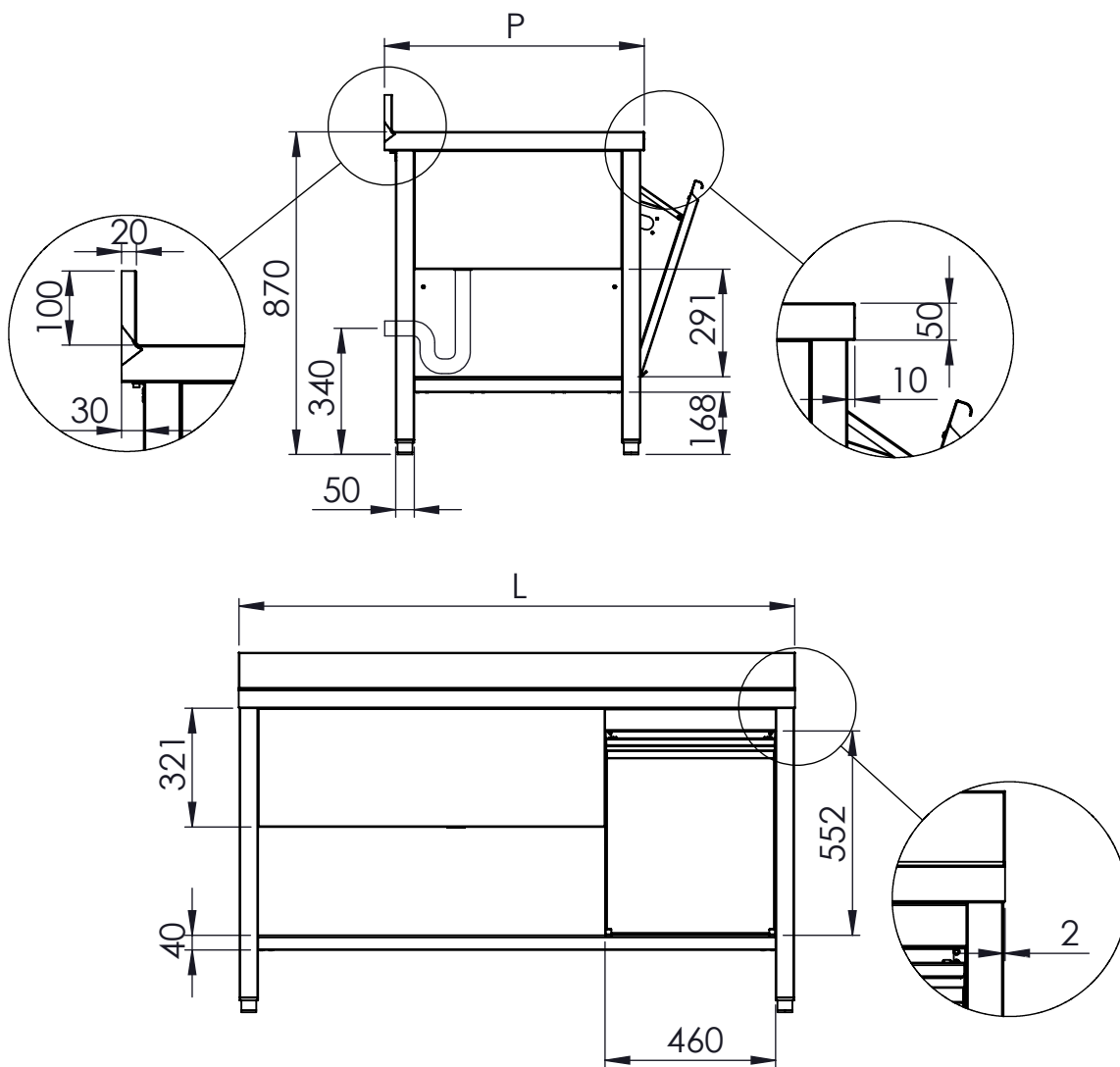

DISEGNATO	
DATA	18/02/2025
PESO	

CODICE: **5F33**

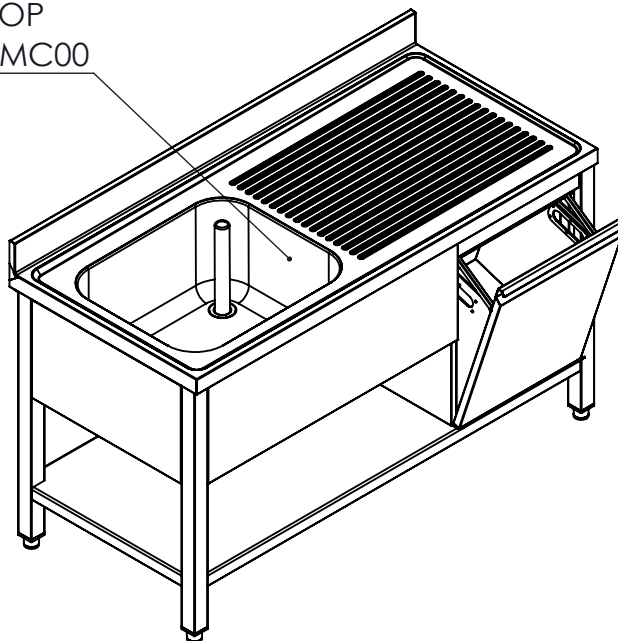

CONFIGURAZIONE:

SCALA: 1:20

A4

FOGLIO 1 DI 1